



KINDRED™

OUTDOORS + SURROUNDS





We are social creatures, meant to be together among the elements. To feel the crisp air over our sun-tired skin. To enjoy the warmth of a fire on our chilly toes. To take our coffees with the sunrise, and to trade stories into the night.

At Kindred Outdoors & Surrounds, drawing people together is what we do.

With hand-forged fire bowls, fireplace surrounds, and outdoor living spaces, we create atmospheres where people can commune, converse, and return to comfort. Spaces distinguished by craftsmanship, accentuated by firelight, and designed to draw us near.

It's a little bit of nature and a little bit nurture, all brought together into one kindred space, where we can be together among the elements.



Elegant solutions for luxurious outdoor spaces.

There's nothing quite like the pleasure of gathering friends and family in your own luxurious outdoor living space. With our outdoor products, there are a number of ways to create your very own personal retreat ranging from elegant fire bowls to inviting seating walls to beautiful outdoor kitchens. Kindred Outdoors & Surrounds seamlessly marries design and functionality making it easier than ever to create your memorable space.



Fireplaces forged with the heritage of craftsmanship.

The fireplace is quite possibly one of the most dramatic spaces in any home. With the unique power to mesmerize, a fire draws us closer to its warmth. Such beauty and drama beckons for an elegant frame.

Our fireplace surrounds are handcrafted to create a distinctive one-of-a-kind appearance, normally only found with natural carved limestone. Explore the stylistic array of surrounds, ranging from contemporary to traditional designs.



Artisan Fire Bowls

Warmth, Style & Ambiance.

Kindred Fire Bowls bring a heightened level of design and elegance to any outdoor space. Made from strong, glass-fiber reinforced concrete and hand-sanded through a four-step finishing process, each Artisan Fire Bowl renders a true one-of-a-kind creation with subtle variations in color and texture similar to natural limestone. Fire Bowls ship complete with lava rock and match-lit components complying with CSA standards for natural gas or liquid propane. Choose from four colors in either Honed or Travertine finishes.



Black Sand
Honed

Black Sand
Travertine

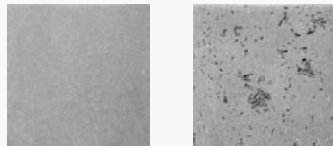

Aged Teak
Honed

Aged Teak
Travertine



Oak Barrel
Honed

Oak Barrel
Travertine

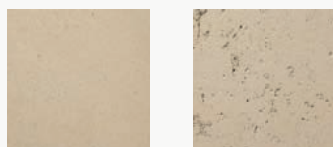

Oyster Shell
Honed

Oyster Shell
Travertine

Industry-Leading Burners

Patent-pending burner system comes complete with powerful 65,000 BTU burner, all brass fittings, heavy duty stainless steel platform and 10-year limited warranty. Innovative brass burner system uses half the fuel of conventional fire rings, yet produces higher flames and brighter appearance.



The **Infinite** in **Aged Teak** with a **Honed Finish**.

Infinite™

The Infinite is limitless in its design applications. The simple, yet elegant shape will naturally draw attention for its style and inviting warmth. Perfect for both residential and commercial applications, the Infinite changes appearance from modern to traditional by selecting the Travertine finish.

36.25" DIA × 18.5" H



The **Kulm** in **Oyster Shell** with a **Honed Finish**.

Kulm™

Experience the balance and symmetry of the elliptical Kulm fire bowl. Elegant and engaging, the sweeping lines soften the design while commanding attention in any environment.

40"L x 20.25"W x 15"H

60"L x 28.75"W x 15"H



Mezzaluna™

Mezzaluna, which translates to half-moon in Italian, exhibits a low profile at only 15" high with a generous 48" circumference. Its perfect symmetry delivers an elegant simplicity to complement any aesthetic taste.

48"DIA x 15"H



The **Mezzaluna** in **Oyster Shell** with a **Honed Finish**.



Marbella™

The Marbella fire bowl captures the essence of the Romanesque period. Its gently rounded bull nose and elegant foundation are hand sanded, creating the natural feel and texture of limestone. The Marbella is perfect for a variety of traditional landscape settings.

38.25"DIA x 20.375"H



The **Marbella** in **Oak Barrel** with a **Travertine Finish**.



The **Tuya** in **Black Sand** with a **Honed Finish**.

Photo: © 2024 Phil Kean Design Group, Photography by Uneek Luxury Tours



Tuya™

Create a memorable outdoor area with high design and functionality. The versatile Tuya delivers the best of both worlds incorporating ample table space for entertaining along an artful circular fire feature.

60"L x 36"W x 15"H



The 42" **Lyra** in **Black Sand** with a **Honed Finish**.

Photography by Uneek Luxury Tours



Lyra™

Lyra exudes a modern linear design with a gently sloped fire feature. Sharp 90-degree inset walls add to this unique monolithic concrete design. The ideal application for any residential or commercial outdoor space.

42"L x 24"W x 15"H

60"L x 24"W x 15"H



The **Talus** in **Black Sand** with a **Honed Finish**.

Talus™

The monolithic square design of Talus creates an impressive contemporary centerpiece. Equally pleasing from all angles, this gently sloped circular fire feature will draw friends and family together.

40"sq x 15"H

Photo: © 2024 Phil Kean Design Group, Photography by Uneek Luxury Tours



Equa™

The subtle curves of the Equa fire bowl form a pleasing shape ideal for intimate conversation spaces or a personal retreat. Begin or end your day with a cup of relaxation, a favorite book and ample warmth.

20" DIA x 15"H

Propane Tank Enclosure

When using liquid propane, select a matching Propane Tank Enclosure to discreetly house the tank and create an elegant end table. Available in all Fire Bowl colors and finishes.

19"D x 19"W x 22.375"H

The **Bloc** in **Black Sand** with a **Honed Finish**.

Bloc™

Bloc delivers the perfect balance of simplicity and scale. At only 20" square, Bloc provides a surprising amount of warmth. Anchor small seating areas or highlight outdoor elements with this handsome fire feature.

20"sq x 15"H



Wood Table Tops

Extend the use of your artisan fire bowl with our customized high quality Iroko wood table tops. Available for all our fire bowl designs.



The Artisan Fire Bowl **Wood Table Top** shown on the **Infinite**.



Signature Kitchens™

Pre-Designed, Ready to Install. Signature Kitchens allow you to construct the perfect outdoor kitchen in days vs. weeks. Each kitchen has been pre-designed to fit a variety of size and style configurations and ships complete with all necessary cabinets, bolts and end-caps. Finalize your outdoor design by selecting a stone finish, appliances and countertop material of your choice.



The **ParkView** Signature Kitchen installed with an ashlar stone.

ParkView™

Includes:

- 1 Qty. 24" Straight Cabinet
- 1 Qty. 48" Straight Cabinet
- 1 Qty. 60" Straight Cabinet
- 1 Qty. 90° Corner Cabinet
- 2 Qty. Cabinet End Caps
- 3 Qty. Fastener Sets
- 2 Qty. Vents

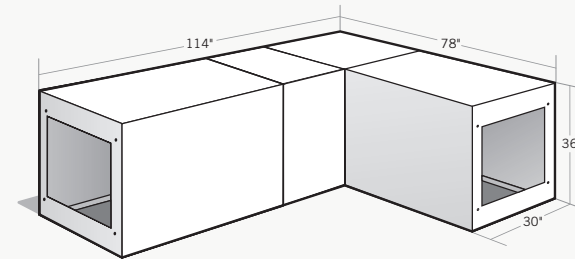

CoastalRanch™

The **CoastalRanch** Signature Kitchen installed with installed with a fieldledge stone.

Includes:

- 2 Qty. 24" Straight Cabinets
- 1 Qty. 48" Straight Cabinet
- 1 Qty. Bar-Height 90° Corner Cabinet with 10" Cantilever
- 2 Qty. Bar-Height Cabinet with 10" Cantilevers
- 2 Qty. Cabinet End Caps
- 5 Qty. Fastener Sets
- 2 Qty. Vents

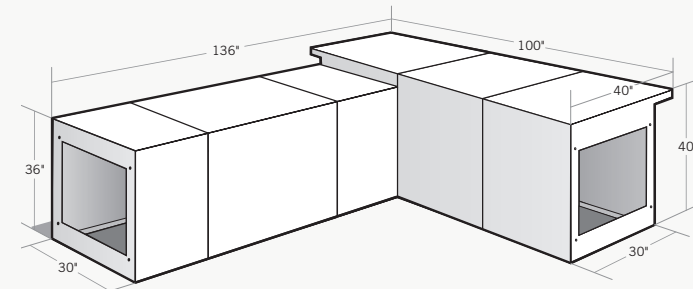

The **Metropolitan** Signature Kitchen installed with a stacked stone.

Metropolitan™

Includes:

- 1 Qty. 36" Straight Cabinet
- 1 Qty. 48" Straight Cabinet
- 1 Qty. 60" Straight Cabinet
- 2 Qty. Cabinet End Caps
- 2 Qty. Fastener Sets
- 2 Qty. Vents

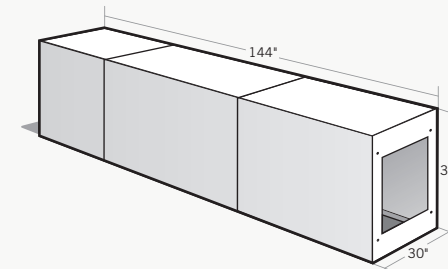



Outdoor Cabinets

Outdoor Luxury Made Simple, In Just 5 Steps!

Kindred Outdoors has redefined how to build outdoor living spaces with a collection of strong, yet lightweight building blocks. The blocks quickly assemble into custom barbecue islands, fireplaces, fire pits and more—ready to be dressed with stone or brick within hours.



At right: The **Metropolitan** Signature Kitchen installed with a stacked stone.

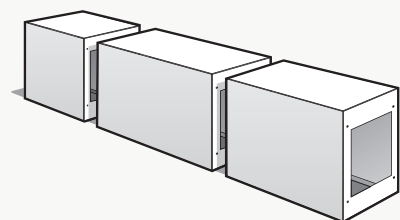

Step 1 Pre-Planning & Design

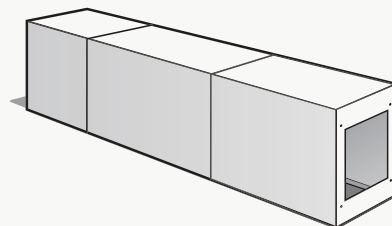

Step 2 Install Kindred Outdoors Cabinets

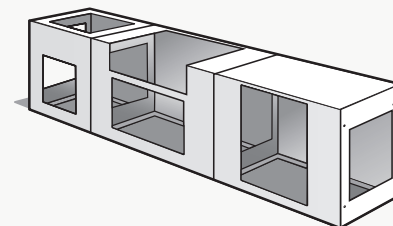

Step 3 Cut Appliance Openings

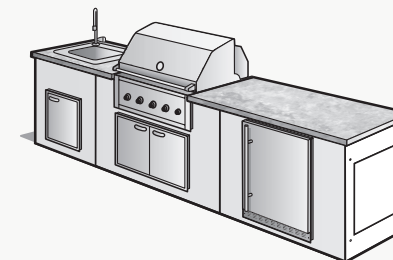

Step 4 Install Appliances & Countertop

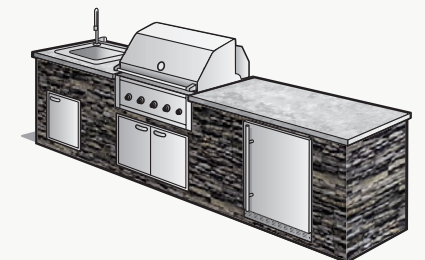

Step 5 Install stone or brick finish.

Kindred Outdoors vs. CMU Concrete Block

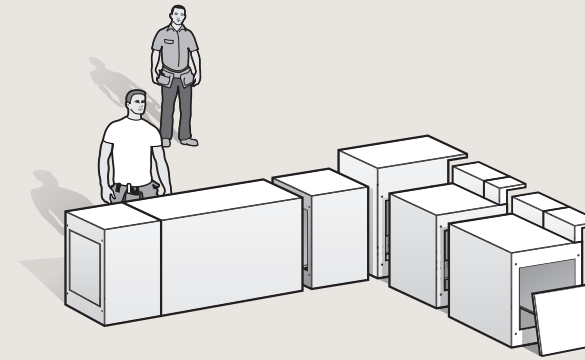

Kindred Outdoors: 6 Outdoor Cabinets
4 Raised Backsplashes
2 End Caps
Hand Tools
2 People
1 Day



CMU Concrete Block: 160 Qty. Concrete Blocks
200 Ft. Rebar
45 Qty. Bags of Cement
Heavy Equipment
4 People
7 Days



The sheer magnitude of materials, time and manpower required to build a CMU Concrete Block kitchen compared to Kindred Outdoors is well illustrated in this example. Kindred Outdoors allows you to create beautiful and authentic masonry outdoor spaces in less than half the time compared to traditional building techniques. The strong, yet lightweight material doesn't require additional concrete footings, bending rebar, or any of the mess, waste and time associated with CMU installations.



90° Corner Cabinets

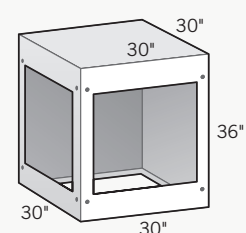

90° Corner Cabinet
30"D x 30"L x 36"H

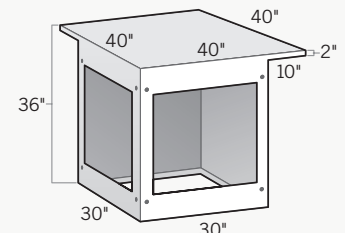

90° Corner Cabinet with 10" Cantilever on Two Sides
30"D x 30"L x 36"H

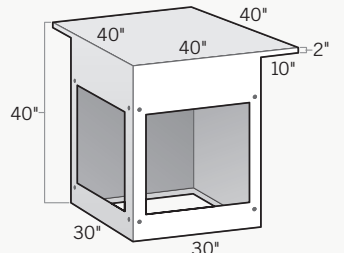

Bar-Height 90° Corner Cabinet with 10" Cantilever on Two Sides
30"D x 30"L x 40"H

Cabinets + Accessories

The Building Blocks. Kindred Outdoors products quickly assemble into a virtually limitless combination of configurations. Each piece is made of glass-fiber reinforced concrete (GFRC) which can be installed on any solid flooring surface without concrete footings or rebar. Eliminated is the

construction waste and additional time associated with traditional masonry block installations. Kindred Outdoors products can be assembled in just hours; even cut-outs for barbecues, sinks, drawers and burners can be done on-site.

Walls, Columns + Accessories

Straight (Linear) Cabinets

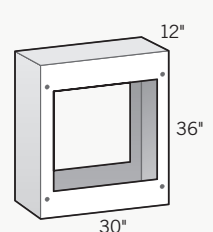

12" Cabinet
30"D x 36"H

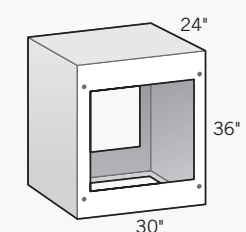

24" Cabinet
30"D x 36"H

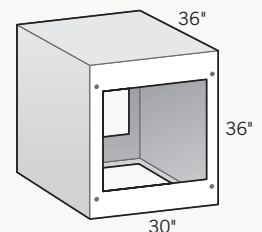

36" Cabinet
30"D x 36"H

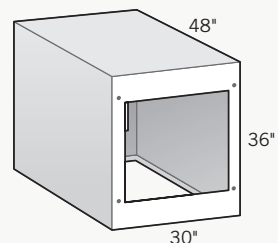

48" Cabinet
30"D x 36"H

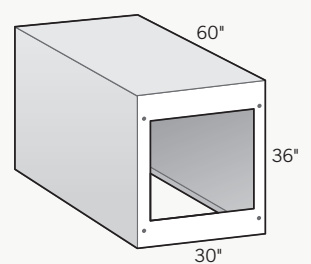

60" Cabinet
30"D x 36"H

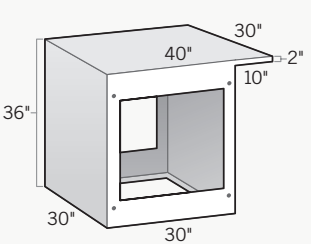

Cabinet with 10" Cantilever Backside
30"D x 30"L x 36"H

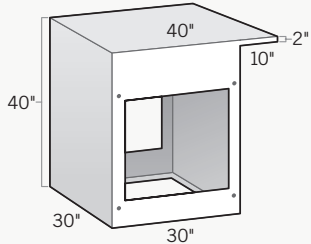

Bar-Height Cabinet with 10" Cantilever Backside
30"D x 30"L x 36"H

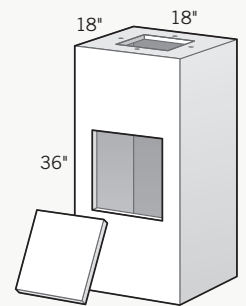

Column with End Cap
18"D x 18"L x 36"H
Instantly build perfect stone or brick columns. Ships with access panel. Designed with top and bottom flange for attaching masonry anchor or bolting.

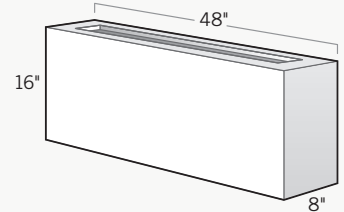

Straight Seating Wall
8"D x 48"L x 16"H
Create seating walls in hours vs. days. Finish with stone, brick and wall caps for an authentic masonry appearance.

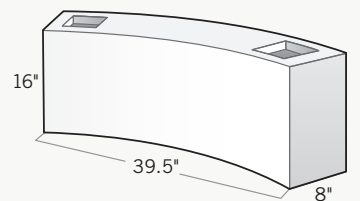

Curved Seating Wall (1/8 Circle)
8"D x 39.5"L x 16"H
Curved seating wall has a 51" radius from the center point to the inside edge, perfect for pairing with our round fire pit.

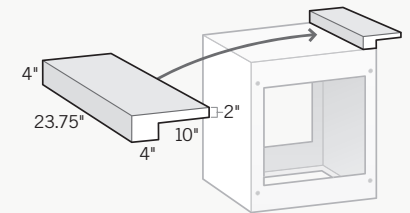

Straight Raised Backsplash
Creates 4" high raised backsplash (23.75" long) with 10" cantilever and 14" counter surface. Requires 3 bolts for mounting (not included).

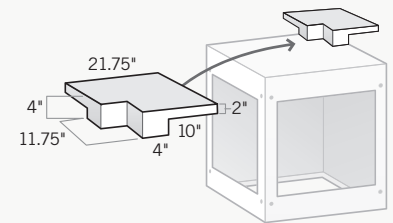

Corner Raised Backsplash
Creates a 4" high raised corner backsplash with a 10" cantilever; connects to straight raised backsplash for L-shaped configurations. Requires 2 bolts for mounting (not included).

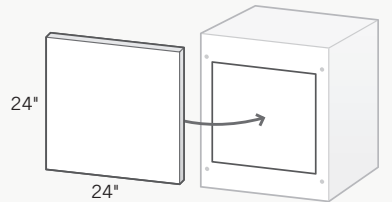

Cabinet End Cap
24" x 24"sq
End caps complete the installation by closing off openings on either end of assembled island.

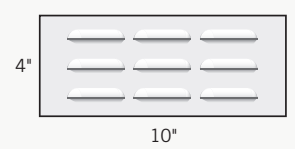

Vent
Vents are recommended by many barbecue appliance manufacturers when installing gas appliances into a closed cabinet.



Appliance Bracket Set
Includes 2 brackets & screws for use with drawers, doors, etc. Works with flanges to secure items in cabinet cut-outs.

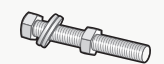

Fastener Set
Includes 4 nuts, 4 bolts & 8 washers. One fastener set is required to secure two cabinets.



Fireplaces + Fire Pits

Inviting Fireside Chats.

Sitting fireside in your backyard has never been easier. Choose from our unique design options and fuel types for Fireplaces and Fire Pits. Each Fireplace and Fire Pit is ready to be dressed with stone or brick for the ultimate masonry appearance.

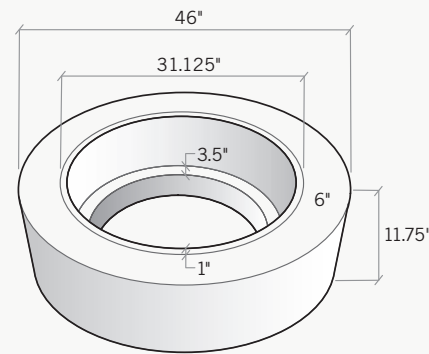

Kittredge™ Gas-Burning Fire Pit

The Kittredge Fire Pit is the perfect centerpiece to your outdoor room. Combine it with our curved seating walls which match the radius perfectly and you're bound to start some great fireside conversations.

46" DIA x 11.75"H



The Kittredge Fire Pit finished with a ledgerstone.



Wilmington™ Gas-Burning Fireplace

The Wilmington Fireplace features architectural touches such as an arched opening and cantilevered mantel for an elegant design. Delivered complete with a scratch-coat surface, the Wilmington can be finished for an impressive custom masonry appearance.

37"D x 68"L x 81"H

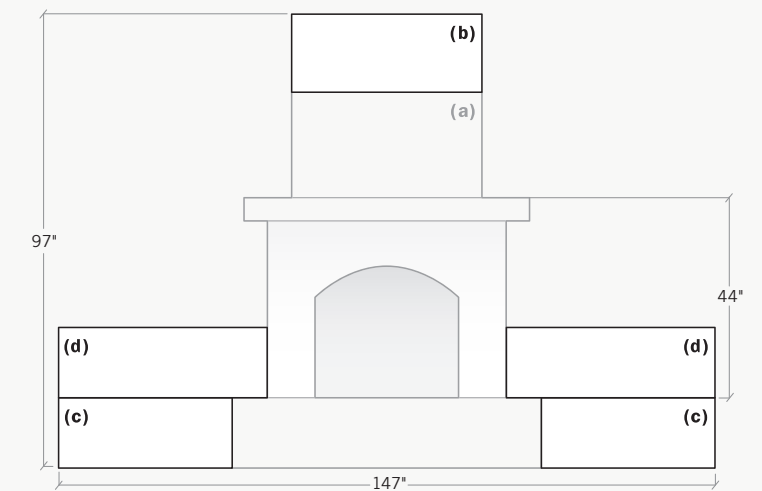
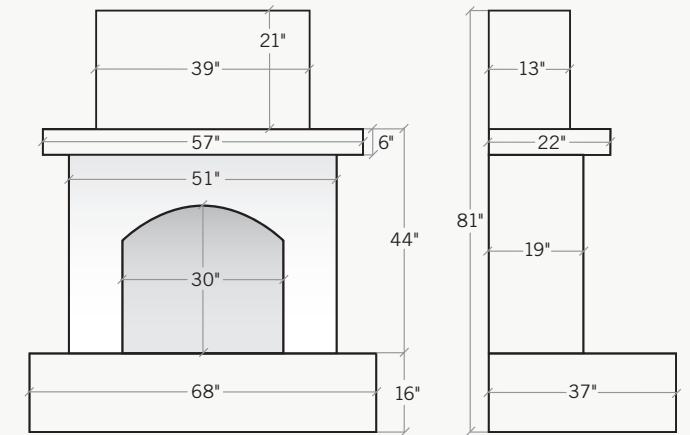

Gas-Burning Fireplace Extensions

(a) Gas-Burning Fireplace | (b) Chimney Extension
(c) Hearth Extension | (d) Hearth Extension Backrest

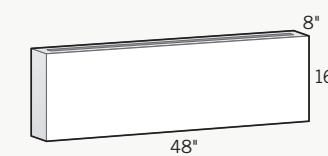

**Wilmington Gas-Burning Fireplace
Hearth Extension Backrest**
8"D x 48"L x 16"H

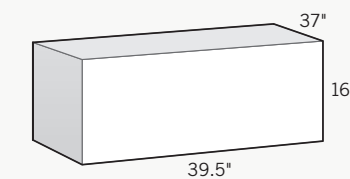

**Wilmington Gas-Burning
Fireplace Hearth Extension**
37"D x 39.5"L x 16"H

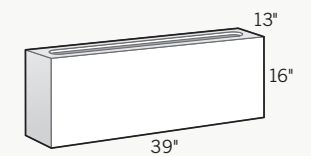

**Wilmington Gas-Burning
Fireplace Chimney Extension**
13"D x 39"L x 16"H

Sherwood™

Wood-Burning Fireplace

The Sherwood Fireplace creates a focal point in your open air conversation setting while providing the warmth and pleasant crackle of burning wood. A design statement, the Sherwood can be dressed with any stone and accessories to complement and enhance your outdoor living space.

47"D x 96"L x 93"H

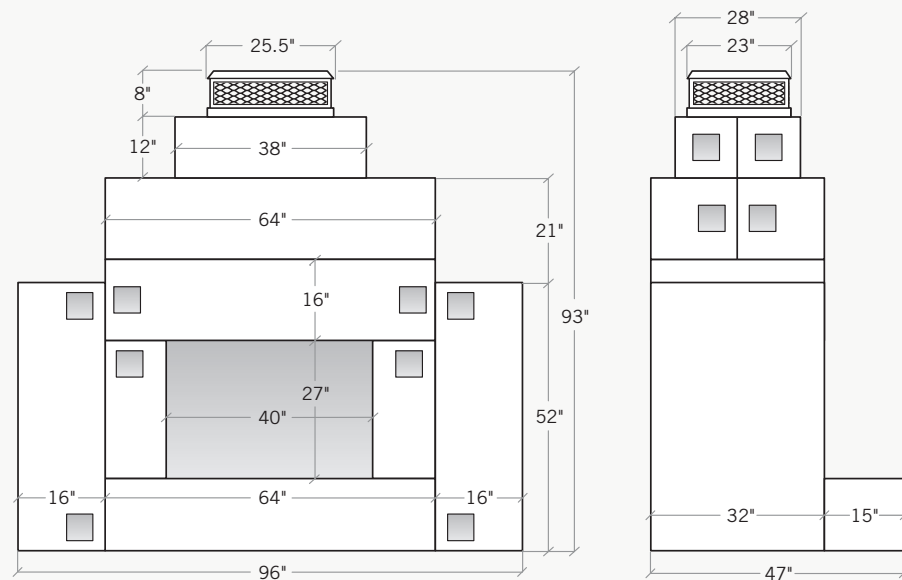

The **Sherwood** Fireplace finished with a stacked stone.



Fireplace Surrounds

Handcrafting a Custom Work of Art

Our Fireplace Surrounds bring elegance and warmth to a wide variety of architectural styles. All designs are handcrafted using a special finishing process, creating the authentic appearance of natural carved limestone with variations in color and texture that add singular beauty to every piece.

The Colors and Textures of Authenticity.

All profiles are available in four colors representing natural limestones found across Europe. Choose from two finishes: a smooth Honed or more textured Travertine.



Black Sand
Honed

Black Sand
Travertine

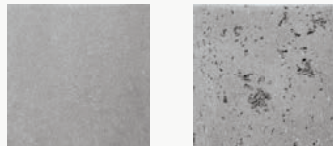

Aged Teak
Honed

Aged Teak
Travertine



Oak Barrel
Honed

Oak Barrel
Travertine

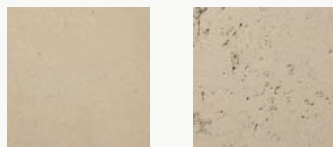

Oyster Shell
Honed

Oyster Shell
Travertine

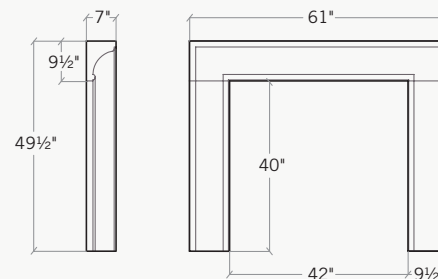

The Soho Boutique in Oyster Shell with a Honed Finish.

The Soho Boutique™

The Soho Boutique is smaller in scale, yet its clean lines imply a sense of luxury and timeless style.

7"D x 61"W x 49.5"H



The Carmela in Oak Barrel with a Honed Finish.

The Carmela™

The Carmela is layered with visual interest beginning with its plinth block foundation and linear legs framed with a unique bull nose detail. The 11.5" depth mantel provides ample space for decor.

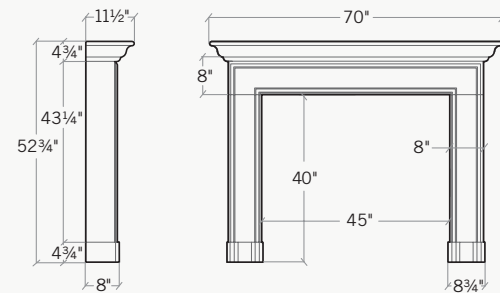

11.5"D x 70"W x 52.75"H

The Sofia in Oak Barrel with a Travertine Finish.

The Sofia™

The understated elegance of The Sophia combines both straight lines and flowing curves. The long-established shape works well with traditional settings.

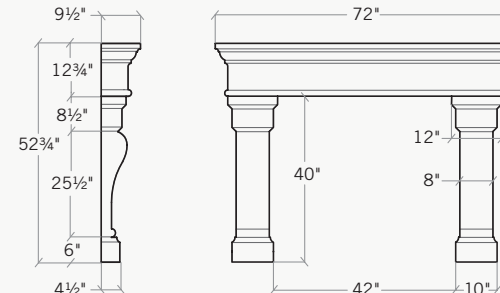

9.5"D x 72"W x 52.75"H



The Palacio in **Oyster Shell** with a **Travertine Finish**.

The Palacio™

The grand form of The Palacio will draw you closer with its impressive size and bold stature. The commanding presence will easily become the focal masterpiece of any luxurious space.

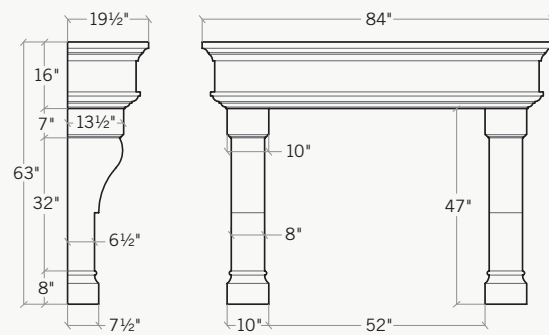

19.5"D x 84"W x 63"H

The Valentina in **Oak Barrel** with a **Travertine Finish**.

The Valentina™

The Valentina will invite a sense of rustic Italian charm into any home. The robust 13" deep mantel paired with two gently sloping pilasters complete its bold presence.

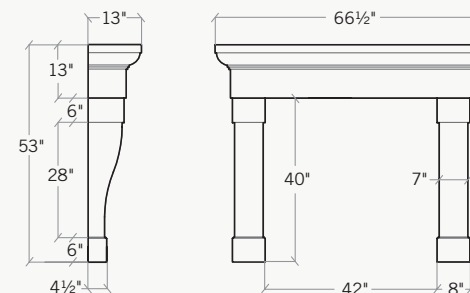

13"D x 66.5"W x 53"H



The Dylan in Aged Teak with a Honed Finish.

The Dylan™

The modern sophistication of The Dylan is evident with its extremely clean lines. The surrounding beveled edges create a distinctive architectural detail.

6"D x 62"W x 51"H

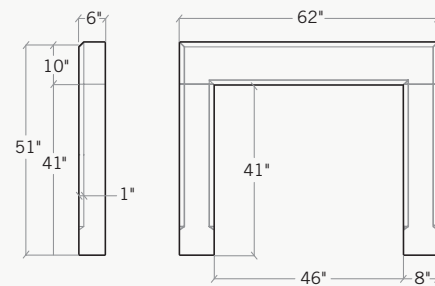

The Florentina in Oyster Shell with a Honed Finish.

The Florentina™

The simple and classical shape creates the perfect frame for a wide variety of fireplace settings. The 9" mantel depth provides ample area to stylize to your specific interior design.

9.25"D x 69"W x 50"H

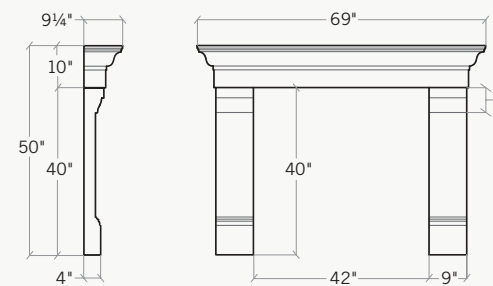



The Annalisa in Oak Barrel with a Honed Finish.

The Annalisa™

Elegance and beauty adorn The Annalisa with its gently sloping arch and detailed carvings. Its scale is designed for larger rooms, perfectly suited for elegant and casual settings alike.

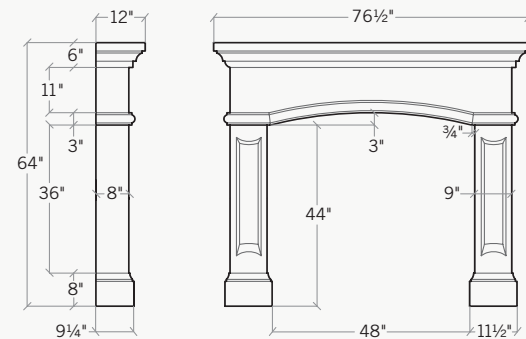

12"D x 76.5"W x 64"H

The Bryant in Oak Barrel with a Travertine Finish.

The Bryant™

The Bryant is an elegant surround that transcends all design styles with multiple layers of intricate yet linear carvings. The base blocks further enhance its stature and solid stance.

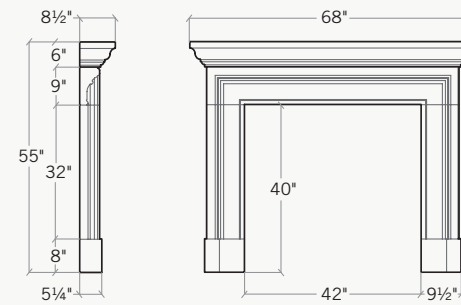

8.5"D x 68"W x 55"H



Mantel Shelves



The Martino

Strong lines and crisp curves make this versatile shelf especially stunning in a modern home. Available in all the Kindred Fireplace Surround colors and finishes.

8" H x 9" D x 48" L OR 60" L

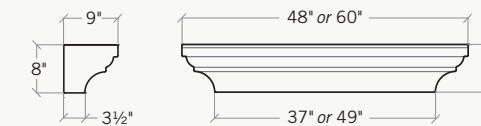

The Angelo

Sweeping curves make this shelf an elegant mantel to grace the walls of any home. Available in all the Kindred Fireplace Surround colors and finishes.

9" H x 9" D x 48" L OR 60" L

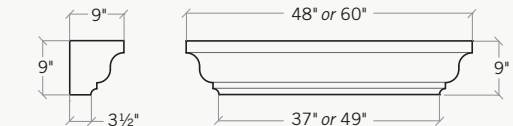

Hearth Stones + Riser Blocks



Hearth Stones

Sold in sets of three with one left, center & right stone and also individually (single center stone). Available in all Kindred Fireplace Surround colors/finishes.

20" D x 24" W x 2" H EACH

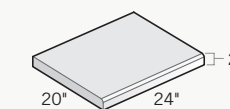

8" Hearth Riser Blocks

Sold in sets of three or individually. Finishes hearth at 10" high with hearth stones; may be trimmed to shorter heights. Available in all the Kindred Fireplace Surround colors and finishes.

19" D x 23.375" W x 8" H EACH

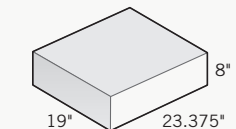

The Giada in Aged Teak with a Honed Finish.

The Giada™

The pleasing blend of clean lines and finite details invite this surround into both transitional and contemporary settings. The 8" monolithic depth gives way to the deeply carved and symmetrical properties.

8" D x 67" W x 52" H

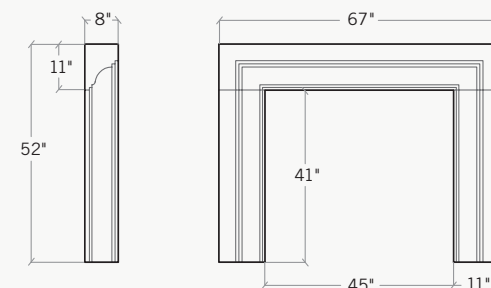

Because Kindred Outdoors & Surrounds finishes replicate natural stone, variations should, and can be expected. Even though colors in this brochure are as close to the actual product as possible, photographic and printing techniques—and actual viewing conditions—can alter perception of color. It is recommended to obtain a sample of a Kindred Outdoors & Surrounds finish before ordering.

If you would like more information on prices, availability of products, the name of your local distributor, or answers to any questions not covered in this brochure, please contact us. We would be happy to assist you with your building plans. Detailed installation instructions, specifications, technical information and test data is available upon request.

SIDING & ACCESSORIES

TRIM & MOULDINGS

ROOFING

STONE

WINDOWS

OUTDOOR LIVING

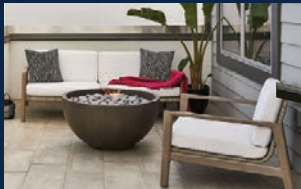
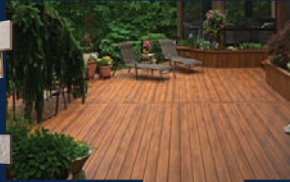

BE BOUNDLESS™

THE PRODUCTS TO DO EVERYTHING. THE POWER TO DO EVEN MORE.

We're answering "what ifs" on a whole new level—from the solutions we create to the dreams we build. We have the tools and technology to tell design stories on a bigger scale and on a more personal level. There are no limits to how far we innovate, how deeply we express, how strongly we commit and how boldly we go.

Together let's Be Boundless™.

Westlake
Royal Building Products™
© 2024 Westlake Royal Building Products

Kindred™ Outdoors + Surrounds
www.MyKindredLiving.com | 800-925-1491
071624

